

SCREW-COVER, TYPE 1

INDUSTRY STANDARDS

UL 50, 50E Listed; Type 1; File No. E27525
 cUL Listed per CSA C22.2 No 40; Type 1; File No. E27525

NEMA/EEMAC Type 1
 IEC 60529, IP30

APPLICATION

Use this enclosure in commercial and general industrial applications that require a junction or pull box. For flush installations, order flush covers and door frames separately.

FEATURES

- Flat, removable covers with unique keyhole slots fastened with plated steel screws
- Optional easy-to-remove knockouts on all four sides of the enclosure in various sizes.
- Optional flush-mounted door frame and flush cover available
- Provision for grounding
- Mounting holes on back of box

SPECIFICATIONS

- 16, 14 or 12 gauge steel or plated steel

FINISH

ANSI 61 gray polyester powder paint finish inside and out. Unless otherwise specified, all custom pull boxes are finished with ANSI 61 gray polyester powder paint.

ACCESSORIES

- Flush Covers
- Flush-Mount Door Frames
- Grounding Device
- Type 1 Locking Window Pull Box Accessory
- Touch-Up Paint

BULLETIN: A90P1

Standard Product Screw-Cover Type 1 Pull Boxes with Knockouts

Catalog Number	AxBxC in.	AxBxC mm	Style	Body Thickness (ga.)	Cover Thickness (ga.)	Number of Cover Screws	Knockout Pattern Along "A" Sides	Knockout Pattern Along "B" Sides
ASE4X4X3	4.00 x 4.00 x 3.00	102 x 102 x 76	Painted	16	16	2	B-C	B-C
ASG4X4X3	4.00 x 4.00 x 3.00	102 x 102 x 76	Galvanized	16	16	2	B-C	B-C
ASE6X6X3	6.00 x 6.00 x 3.00	152 x 152 x 76	Painted	16	16	2	B-C-D	B-C-D
ASG6X6X3	6.00 x 6.00 x 3.00	152 x 152 x 76	Galvanized	16	16	2	B-C-D	B-C-D
ASE8X6X3	8.00 x 6.00 x 3.00	203 x 152 x 76	Painted	16	16	2	F-G-H-I	B-C-D
ASG8X6X3	8.00 x 6.00 x 3.00	203 x 152 x 76	Galvanized	16	16	2	F-G-H-I	B-C-D
ASE16X14X3	16.00 x 14.00 x 3.00	406 x 356 x 76	Painted	16	16	4	B-C-D-E-F-G-H	B-C-D-E-F-G-H
ASE18X14X3	18.00 x 14.00 x 3.00	457 x 356 x 76	Painted	16	16	4	A-B-C-D-E-F-G-H-I	B-C-D-E-F-G-H
ASE4X4X4	4.00 x 4.00 x 4.00	102 x 102 x 102	Painted	16	16	2	B-C	B-C
ASG4X4X4	4.00 x 4.00 x 4.00	102 x 102 x 102	Galvanized	16	16	2	B-C	B-C
ASE6X4X4	6.00 x 4.00 x 4.00	152 x 102 x 102	Painted	16	16	2	B-C-D	B-C
ASG6X4X4	6.00 x 4.00 x 4.00	152 x 102 x 102	Galvanized	16	16	2	B-C-D	B-C
ASE6X6X4	6.00 x 6.00 x 4.00	152 x 152 x 102	Painted	16	16	2	B-C-D	B-C-D
ASG6X6X4	6.00 x 6.00 x 4.00	152 x 152 x 102	Galvanized	16	16	2	B-C-D	B-C-D
ASE8X6X4	8.00 x 6.00 x 4.00	203 x 152 x 102	Painted	16	16	2	F-G-H-I	B-C-D
ASG8X6X4	8.00 x 6.00 x 4.00	203 x 152 x 102	Galvanized	16	16	2	F-G-H-I	B-C-D
ASE8X8X4	8.00 x 8.00 x 4.00	203 x 203 x 102	Painted	16	16	4	F-G-H-I	F-G-H-I
ASG8X8X4	8.00 x 8.00 x 4.00	203 x 203 x 102	Galvanized	16	16	4	F-G-H-I	F-G-H-I
ASE10X8X4	10.00 x 8.00 x 4.00	254 x 203 x 102	Painted	16	16	4	F-G-H-I	F-G-H-I
ASG10X8X4	10.00 x 8.00 x 4.00	254 x 203 x 102	Galvanized	16	16	4	F-G-H-I	F-G-H-I
ASE10X10X4	10.00 x 10.00 x 4.00	254 x 254 x 102	Painted	16	16	4	F-G-H-I	C-D-E-F-G
ASG10X10X4	10.00 x 10.00 x 4.00	254 x 254 x 102	Galvanized	16	16	4	F-G-H-I	C-D-E-F-G
ASE12X8X4	12.00 x 8.00 x 4.00	305 x 203 x 102	Painted	16	16	4	C-D-E-F-G	F-G-H-I
ASG12X8X4	12.00 x 8.00 x 4.00	305 x 203 x 102	Galvanized	16	16	4	C-D-E-F-G	F-G-H-I
ASE12X10X4	12.00 x 10.00 x 4.00	305 x 254 x 102	Painted	16	16	4	C-D-E-F-G	C-D-E-F-G
ASG12X10X4	12.00 x 10.00 x 4.00	305 x 254 x 102	Galvanized	16	16	4	C-D-E-F-G	C-D-E-F-G
ASE12X12X4	12.00 x 12.00 x 4.00	305 x 305 x 102	Painted	16	16	4	C-D-E-F-G	C-D-E-F-G
ASG12X12X4	12.00 x 12.00 x 4.00	305 x 305 x 102	Galvanized	16	16	4	C-D-E-F-G	C-D-E-F-G
ASE16X12X4	16.00 x 12.00 x 4.00	406 x 305 x 102	Painted	16	16	4	B-C-D-E-F-G-H	C-D-E-F-G
ASG16X12X4	16.00 x 12.00 x 4.00	406 x 305 x 102	Galvanized	16	16	4	B-C-D-E-F-G-H	C-D-E-F-G
ASE18X12X4	18.00 x 12.00 x 4.00	457 x 305 x 102	Painted	16	16	4	A-B-C-D-E-F-G-H-I	C-D-E-F-G
ASG18X12X4	18.00 x 12.00 x 4.00	457 x 305 x 102	Galvanized	16	16	4	A-B-C-D-E-F-G-H-I	C-D-E-F-G
ASE18X18X4	18.00 x 18.00 x 4.00	457 x 457 x 102	Painted	16	16	4	A-B-C-D-E-F-G-H-I	A-B-C-D-E-F-G-H-I
ASG18X18X4	18.00 x 18.00 x 4.00	457 x 457 x 102	Galvanized	16	16	4	A-B-C-D-E-F-G-H-I	A-B-C-D-E-F-G-H-I
ASE24X12X4	24.00 x 12.00 x 4.00	610 x 305 x 102	Painted	16	16	4	A-B-C-D-E-F-G-H-I	C-D-E-F-G
ASG24X12X4	24.00 x 12.00 x 4.00	610 x 305 x 102	Galvanized	16	16	4	A-B-C-D-E-F-G-H-I	C-D-E-F-G
ASE24X24X4	24.00 x 24.00 x 4.00	610 x 610 x 102	Painted	14	16	4	A-B-C-D-E-F-G-H-I	A-B-C-D-E-F-G-H-I
ASG24X24X4	24.00 x 24.00 x 4.00	610 x 610 x 102	Galvanized	14	16	4	A-B-C-D-E-F-G-H-I	A-B-C-D-E-F-G-H-I
ASE30X24X4	30.00 x 24.00 x 4.00	762 x 610 x 102	Painted	14	16	6	A-B-C-D-E-F-G-H-I	A-B-C-D-E-F-G-H-I

Catalog Number	AxBxC in.	AxBxC mm	Style	Body Thickness (ga.)	Cover Thickness (ga.)	Number of Cover Screws	Knockout Pattern Along "A" Sides	Knockout Pattern Along "B" Sides
ASE6X6X6	6.00 x 6.00 x 6.00	152 x 152 x 152	Painted	16	16	2	B-C-D	B-C-D
ASG6X6X6	6.00 x 6.00 x 6.00	152 x 152 x 152	Galvanized	16	16	2	B-C-D	B-C-D
ASE8X6X6	8.00 x 6.00 x 6.00	203 x 152 x 152	Painted	16	16	4	F-G-H-I	B-C-D
ASE8X8X6	8.00 x 8.00 x 6.00	203 x 203 x 152	Painted	16	16	4	F-G-H-I	F-G-H-I
ASG8X8X6	8.00 x 8.00 x 6.00	203 x 203 x 152	Galvanized	16	16	4	F-G-H-I	F-G-H-I
ASE10X8X6	10.00 x 8.00 x 6.00	254 x 203 x 152	Painted	16	16	4	F-G-H-I	F-G-H-I
ASG10X8X6	10.00 x 8.00 x 6.00	254 x 203 x 152	Galvanized	16	16	4	F-G-H-I	F-G-H-I
ASE10X10X6	10.00 x 10.00 x 6.00	254 x 254 x 152	Painted	16	16	4	F-G-H-I	C-D-E-F-G
ASG10X10X6	10.00 x 10.00 x 6.00	254 x 254 x 152	Galvanized	16	16	4	F-G-H-I	C-D-E-F-G
ASE12X10X6	12.00 x 10.00 x 6.00	305 x 254 x 152	Painted	16	16	4	C-D-E-F-G	C-D-E-F-G
ASG12X10X6	12.00 x 10.00 x 6.00	305 x 254 x 152	Galvanized	16	16	4	C-D-E-F-G	C-D-E-F-G
ASE12X12X6	12.00 x 12.00 x 6.00	305 x 305 x 152	Painted	16	16	4	C-D-E-F-G	C-D-E-F-G
ASG12X12X6	12.00 x 12.00 x 6.00	305 x 305 x 152	Galvanized	16	16	4	C-D-E-F-G	C-D-E-F-G
ASE16X12X6	16.00 x 12.00 x 6.00	406 x 305 x 152	Painted	16	16	4	B-C-D-E-F-G-H	C-D-E-F-G
ASG16X12X6	16.00 x 12.00 x 6.00	406 x 305 x 152	Galvanized	16	16	4	B-C-D-E-F-G-H	C-D-E-F-G
ASE16X16X6	16.00 x 16.00 x 6.00	406 x 406 x 152	Painted	16	16	4	B-C-D-E-F-G-H	B-C-D-E-F-G-H
ASG16X16X6	16.00 x 16.00 x 6.00	406 x 406 x 152	Galvanized	16	16	4	B-C-D-E-F-G-H	B-C-D-E-F-G-H
ASE18X12X6	18.00 x 12.00 x 6.00	457 x 305 x 152	Painted	16	16	4	A-B-C-D-E-F-G-H-I	C-D-E-F-G
ASG18X12X6	18.00 x 12.00 x 6.00	457 x 305 x 152	Galvanized	16	16	4	A-B-C-D-E-F-G-H-I	C-D-E-F-G
ASE18X18X6	18.00 x 18.00 x 6.00	457 x 457 x 152	Painted	16	16	4	A-B-C-D-E-F-G-H-I	A-B-C-D-E-F-G-H-I
ASG18X18X6	18.00 x 18.00 x 6.00	457 x 457 x 152	Galvanized	16	16	4	A-B-C-D-E-F-G-H-I	A-B-C-D-E-F-G-H-I
ASE24X18X6	24.00 x 18.00 x 6.00	610 x 457 x 152	Painted	16	14	4	A-B-C-D-E-F-G-H-I	A-B-C-D-E-F-G-H-I
ASG24X18X6	24.00 x 18.00 x 6.00	610 x 457 x 152	Galvanized	16	14	4	A-B-C-D-E-F-G-H-I	A-B-C-D-E-F-G-H-I
ASE24X24X6	24.00 x 24.00 x 6.00	610 x 610 x 152	Painted	14	16	4	A-B-C-D-E-F-G-H-I	A-B-C-D-E-F-G-H-I
ASG24X24X6	24.00 x 24.00 x 6.00	610 x 610 x 152	Galvanized	14	16	4	A-B-C-D-E-F-G-H-I	A-B-C-D-E-F-G-H-I
ASE30X24X6	30.00 x 24.00 x 6.00	762 x 610 x 152	Painted	14	16	6	A-B-C-D-E-F-G-H-I	A-B-C-D-E-F-G-H-I
ASG30X24X6	30.00 x 24.00 x 6.00	762 x 610 x 152	Galvanized	14	16	6	A-B-C-D-E-F-G-H-I	A-B-C-D-E-F-G-H-I
ASE36X24X6	36.00 x 24.00 x 6.00	914 x 610 x 152	Painted	14	16	6	A-B-C-D-E-F-G-H-I	A-B-C-D-E-F-G-H-I
ASG36X24X6	36.00 x 24.00 x 6.00	914 x 610 x 152	Galvanized	14	16	6	A-B-C-D-E-F-G-H-I	A-B-C-D-E-F-G-H-I
ASE8X8X8	8.00 x 8.00 x 8.00	203 x 203 x 203	Painted	16	16	4	F-G-H-I	F-G-H-I
ASE12X12X8	12.00 x 12.00 x 8.00	305 x 305 x 203	Painted	16	16	4	C-D-E-F-G	C-D-E-F-G
ASG12X12X8	12.00 x 12.00 x 8.00	305 x 305 x 203	Galvanized	16	16	4	C-D-E-F-G	C-D-E-F-G
ASE16X12X8	16.00 x 12.00 x 8.00	406 x 305 x 203	Painted	16	16	4	B-C-D-E-F-G-H	C-D-E-F-G
ASG16X12X8	16.00 x 12.00 x 8.00	406 x 305 x 203	Galvanized	16	16	4	B-C-D-E-F-G-H	C-D-E-F-G
ASE18X12X8	18.00 x 12.00 x 8.00	457 x 305 x 203	Painted	16	16	4	A-B-C-D-E-F-G-H-I	C-D-E-F-G
ASG18X12X8	18.00 x 12.00 x 8.00	457 x 305 x 203	Galvanized	16	16	4	A-B-C-D-E-F-G-H-I	C-D-E-F-G
ASE24X18X8	24.00 x 18.00 x 8.00	610 x 457 x 203	Painted	16	14	4	A-B-C-D-E-F-G-H-I	A-B-C-D-E-F-G-H-I
ASG24X18X8	24.00 x 18.00 x 8.00	610 x 457 x 203	Galvanized	16	14	4	A-B-C-D-E-F-G-H-I	A-B-C-D-E-F-G-H-I
ASE24X24X8	24.00 x 24.00 x 8.00	610 x 610 x 203	Painted	14	16	4	A-B-C-D-E-F-G-H-I	A-B-C-D-E-F-G-H-I
ASG24X24X8	24.00 x 24.00 x 8.00	610 x 610 x 203	Galvanized	14	16	4	A-B-C-D-E-F-G-H-I	A-B-C-D-E-F-G-H-I
ASE30X24X8	30.00 x 24.00 x 8.00	762 x 610 x 203	Painted	14	16	6	A-B-C-D-E-F-G-H-I	A-B-C-D-E-F-G-H-I
ASG30X24X8	30.00 x 24.00 x 8.00	762 x 610 x 203	Galvanized	14	16	6	A-B-C-D-E-F-G-H-I	A-B-C-D-E-F-G-H-I
ASE36X24X8	36.00 x 24.00 x 8.00	914 x 610 x 203	Painted	14	16	6	A-B-C-D-E-F-G-H-I	A-B-C-D-E-F-G-H-I
ASG36X24X8	36.00 x 24.00 x 8.00	914 x 610 x 203	Galvanized	14	16	6	A-B-C-D-E-F-G-H-I	A-B-C-D-E-F-G-H-I
ASE18X12X10	18.00 x 12.00 x 10.00	457 x 305 x 254	Painted	16	16	4	A-B-C-D-E-F-G-H-I	C-D-E-F-G
ASG18X12X10	18.00 x 12.00 x 10.00	457 x 305 x 254	Galvanized	16	16	4	A-B-C-D-E-F-G-H-I	C-D-E-F-G
ASE24X18X10	24.00 x 18.00 x 10.00	610 x 457 x 254	Painted	16	14	4	A-B-C-D-E-F-G-H-I	A-B-C-D-E-F-G-H-I
ASG24X18X10	24.00 x 18.00 x 10.00	610 x 457 x 254	Galvanized	16	14	4	A-B-C-D-E-F-G-H-I	A-B-C-D-E-F-G-H-I
ASE24X24X10	24.00 x 24.00 x 10.00	610 x 610 x 254	Painted	14	16	4	A-B-C-D-E-F-G-H-I	A-B-C-D-E-F-G-H-I
ASG24X24X10	24.00 x 24.00 x 10.00	610 x 610 x 254	Galvanized	14	16	4	A-B-C-D-E-F-G-H-I	A-B-C-D-E-F-G-H-I
ASE36X24X10	36.00 x 24.00 x 10.00	914 x 610 x 254	Painted	14	16	6	A-B-C-D-E-F-G-H-I	A-B-C-D-E-F-G-H-I
ASG36X24X10	36.00 x 24.00 x 10.00	914 x 610 x 254	Galvanized	14	16	6	A-B-C-D-E-F-G-H-I	A-B-C-D-E-F-G-H-I
ASE24X12X12	24.00 x 12.00 x 12.00	610 x 305 x 305	Painted	16	16	4	A-B-C-D-E-F-G-H-I	C-D-E-F-G
ASG24X12X12	24.00 x 12.00 x 12.00	610 x 305 x 305	Galvanized	16	16	4	A-B-C-D-E-F-G-H-I	C-D-E-F-G
ASE18X18X12	18.00 x 18.00 x 12.00	457 x 457 x 305	Painted	16	16	4	A-B-C-D-E-F-G-H-I	A-B-C-D-E-F-G-H-I
ASG18X18X12	18.00 x 18.00 x 12.00	457 x 457 x 305	Galvanized	16	16	4	A-B-C-D-E-F-G-H-I	A-B-C-D-E-F-G-H-I
ASE24X18X12	24.00 x 18.00 x 12.00	610 x 457 x 305	Painted	16	14	4	A-B-C-D-E-F-G-H-I	A-B-C-D-E-F-G-H-I
ASG24X18X12	24.00 x 18.00 x 12.00	610 x 457 x 305	Galvanized	16	14	4	A-B-C-D-E-F-G-H-I	A-B-C-D-E-F-G-H-I
ASE24X24X12	24.00 x 24.00 x 12.00	610 x 610 x 305	Painted	14	16	4	A-B-C-D-E-F-G-H-I	A-B-C-D-E-F-G-H-I
ASG24X24X12	24.00 x 24.00 x 12.00	610 x 610 x 305	Galvanized	14	16	4	A-B-C-D-E-F-G-H-I	A-B-C-D-E-F-G-H-I
ASE36X24X12	36.00 x 24.00 x 12.00	914 x 610 x 305	Painted	14	16	6	A-B-C-D-E-F-G-H-I	A-B-C-D-E-F-G-H-I
ASG36X24X12	36.00 x 24.00 x 12.00	914 x 610 x 305	Galvanized	14	16	6	A-B-C-D-E-F-G-H-I	A-B-C-D-E-F-G-H-I

Standard Product **Screw-Cover Type 1 Pull Boxes without Knockouts**

Catalog Number	AxBxC in.	AxBxC mm	Style	Body Thickness (ga.)	Cover Thickness (ga.)	Number of Cover Screws
ASE4X4X3NK	4.00 x 4.00 x 3.00	102 x 102 x 76	Painted	16	16	2
ASG4X4X3NK	4.00 x 4.00 x 3.00	102 x 102 x 76	Galvanized	16	16	2
ASE6X6X3NK	6.00 x 6.00 x 3.00	152 x 152 x 76	Painted	16	16	2
ASG6X6X3NK	6.00 x 6.00 x 3.00	152 x 152 x 76	Galvanized	16	16	2
ASE8X6X3NK	8.00 x 6.00 x 3.00	203 x 152 x 76	Painted	16	16	2
ASG8X6X3NK	8.00 x 6.00 x 3.00	203 x 152 x 76	Galvanized	16	16	2
ASE16X14X3NK	16.00 x 14.00 x 3.00	406 x 356 x 76	Painted	16	16	4
ASG20X14X3NK	20.00 x 14.00 x 3.00	508 x 356 x 76	Painted	16	16	4
ASE4X4X4NK	4.00 x 4.00 x 4.00	102 x 102 x 102	Painted	16	16	2
ASG4X4X4NK	4.00 x 4.00 x 4.00	102 x 102 x 102	Galvanized	16	16	2
ASE6X6X4NK	6.00 x 4.00 x 4.00	152 x 102 x 102	Painted	16	16	2
ASG6X6X4NK	6.00 x 4.00 x 4.00	152 x 102 x 102	Galvanized	16	16	2
ASE6X6X4NK	6.00 x 6.00 x 4.00	152 x 152 x 102	Painted	16	16	2
ASG6X6X4NK	6.00 x 6.00 x 4.00	152 x 152 x 102	Galvanized	16	16	2
ASE8X6X4NK	8.00 x 6.00 x 4.00	203 x 152 x 102	Painted	16	16	2
ASG8X6X4NK	8.00 x 6.00 x 4.00	203 x 152 x 102	Galvanized	16	16	2
ASE8X8X4NK	8.00 x 8.00 x 4.00	203 x 203 x 102	Painted	16	16	4
ASG8X8X4NK	8.00 x 8.00 x 4.00	203 x 203 x 102	Galvanized	16	16	4
ASE10X6X4NK	10.00 x 6.00 x 4.00	254 x 152 x 102	Painted	16	16	4
ASG10X6X4NK	10.00 x 6.00 x 4.00	254 x 152 x 102	Galvanized	16	16	4
ASE10X8X4NK	10.00 x 8.00 x 4.00	254 x 203 x 102	Painted	16	16	4
ASG10X8X4NK	10.00 x 8.00 x 4.00	254 x 203 x 102	Galvanized	16	16	4
ASE10X10X4NK	10.00 x 10.00 x 4.00	254 x 254 x 102	Painted	16	16	4
ASG10X10X4NK	10.00 x 10.00 x 4.00	254 x 254 x 102	Galvanized	16	16	4
ASE12X6X4NK	12.00 x 6.00 x 4.00	305 x 152 x 102	Painted	16	16	4
ASG12X6X4NK	12.00 x 6.00 x 4.00	305 x 152 x 102	Galvanized	16	16	4



Catalog Number	AxBxC in.	AxBxC mm	Style	Body Thickness (ga.)	Cover Thickness (ga.)	Number of Cover Screws
ASE12X8X4NK	12.00 x 8.00 x 4.00	305 x 203 x 102	Painted	16	16	4
ASG12X8X4NK	12.00 x 8.00 x 4.00	305 x 203 x 102	Galvanized	16	16	4
ASE12X10X4NK	12.00 x 10.00 x 4.00	305 x 254 x 102	Painted	16	16	4
ASG12X10X4NK	12.00 x 10.00 x 4.00	305 x 254 x 102	Galvanized	16	16	4
ASE12X12X4NK	12.00 x 12.00 x 4.00	305 x 305 x 102	Painted	16	16	4
ASG12X12X4NK	12.00 x 12.00 x 4.00	305 x 305 x 102	Galvanized	16	16	4
ASE15X15X4NK	15.00 x 15.00 x 4.00	381 x 381 x 102	Painted	16	16	4
ASG15X15X4NK	15.00 x 15.00 x 4.00	381 x 381 x 102	Galvanized	16	16	4
ASE16X12X4NK	16.00 x 12.00 x 4.00	406 x 305 x 102	Painted	16	16	4
ASG16X12X4NK	16.00 x 12.00 x 4.00	406 x 305 x 102	Galvanized	16	16	4
ASE18X12X4NK	18.00 x 12.00 x 4.00	457 x 305 x 102	Painted	16	16	4
ASG18X12X4NK	18.00 x 12.00 x 4.00	457 x 305 x 102	Galvanized	16	16	4
ASE18X15X4NK	18.00 x 15.00 x 4.00	457 x 381 x 102	Painted	16	16	4
ASG18X15X4NK	18.00 x 15.00 x 4.00	457 x 381 x 102	Galvanized	16	16	4
ASE18X18X4NK	18.00 x 18.00 x 4.00	457 x 457 x 102	Painted	16	16	4
ASG18X18X4NK	18.00 x 18.00 x 4.00	457 x 457 x 102	Galvanized	16	16	4
ASE24X12X4NK	24.00 x 12.00 x 4.00	610 x 305 x 102	Painted	16	16	4
ASG24X12X4NK	24.00 x 12.00 x 4.00	610 x 305 x 102	Galvanized	16	16	4
ASE24X18X4NK	24.00 x 18.00 x 4.00	610 x 457 x 102	Painted	16	14	4
ASG24X18X4NK	24.00 x 18.00 x 4.00	610 x 457 x 102	Galvanized	16	16	4
ASE24X24X4NK	24.00 x 24.00 x 4.00	610 x 610 x 102	Painted	16	16	4
ASG24X24X4NK	24.00 x 24.00 x 4.00	610 x 610 x 102	Galvanized	16	16	4
ASE30X24X4NK	30.00 x 24.00 x 4.00	762 x 610 x 102	Painted	16	16	6
ASG30X24X4NK	30.00 x 24.00 x 4.00	762 x 610 x 102	Galvanized	16	16	8
ASE6X6X6NK	6.00 x 6.00 x 6.00	152 x 152 x 152	Painted	16	16	2
ASG6X6X6NK	6.00 x 6.00 x 6.00	152 x 152 x 152	Galvanized	16	16	2
ASE8X6X6NK	8.00 x 6.00 x 6.00	203 x 152 x 152	Painted	16	16	2
ASG8X6X6NK	8.00 x 6.00 x 6.00	203 x 152 x 152	Galvanized	16	16	2
ASE8X8X6NK	8.00 x 8.00 x 6.00	203 x 203 x 152	Painted	16	16	4
ASG8X8X6NK	8.00 x 8.00 x 6.00	203 x 203 x 152	Galvanized	16	16	4
ASE10X8X6NK	10.00 x 8.00 x 6.00	254 x 203 x 152	Painted	16	16	4
ASG10X8X6NK	10.00 x 8.00 x 6.00	254 x 203 x 152	Galvanized	16	16	4
ASE10X10X6NK	10.00 x 10.00 x 6.00	254 x 254 x 152	Painted	16	16	4
ASG10X10X6NK	10.00 x 10.00 x 6.00	254 x 254 x 152	Galvanized	16	16	4
ASE12X6X6NK	12.00 x 6.00 x 6.00	305 x 152 x 152	Painted	16	16	4
ASG12X6X6NK	12.00 x 6.00 x 6.00	305 x 152 x 152	Galvanized	16	16	4
ASE12X8X6NK	12.00 x 8.00 x 6.00	305 x 203 x 152	Painted	16	16	4
ASG12X8X6NK	12.00 x 8.00 x 6.00	305 x 203 x 152	Galvanized	16	16	4
ASE12X10X6NK	12.00 x 10.00 x 6.00	305 x 254 x 152	Painted	16	16	4
ASG12X10X6NK	12.00 x 10.00 x 6.00	305 x 254 x 152	Galvanized	16	16	4
ASE12X12X6NK	12.00 x 12.00 x 6.00	305 x 305 x 152	Painted	16	16	4
ASG12X12X6NK	12.00 x 12.00 x 6.00	305 x 305 x 152	Galvanized	16	16	4
ASE16X12X6NK	16.00 x 12.00 x 6.00	406 x 305 x 152	Painted	16	16	4
ASG16X12X6NK	16.00 x 12.00 x 6.00	406 x 305 x 152	Galvanized	16	16	4
ASE16X16X6NK	16.00 x 16.00 x 6.00	406 x 406 x 152	Painted	16	16	4
ASG16X16X6NK	16.00 x 16.00 x 6.00	406 x 406 x 152	Galvanized	16	16	4
ASE18X12X6NK	18.00 x 12.00 x 6.00	457 x 305 x 152	Painted	16	16	4
ASG18X12X6NK	18.00 x 12.00 x 6.00	457 x 305 x 152	Galvanized	16	16	4
ASE18X18X6NK	18.00 x 18.00 x 6.00	457 x 457 x 152	Painted	16	16	4
ASG18X18X6NK	18.00 x 18.00 x 6.00	457 x 457 x 152	Galvanized	16	16	4
ASE24X12X6NK	24.00 x 12.00 x 6.00	610 x 305 x 152	Painted	16	16	4
ASG24X12X6NK	24.00 x 12.00 x 6.00	610 x 305 x 152	Galvanized	16	16	4
ASE24X18X6NK	24.00 x 18.00 x 6.00	610 x 457 x 152	Painted	16	14	4
ASG24X18X6NK	24.00 x 18.00 x 6.00	610 x 457 x 152	Galvanized	16	16	4
ASE24X20X6NK	24.00 x 20.00 x 6.00	610 x 508 x 152	Painted	14	16	4
ASG24X20X6NK	24.00 x 20.00 x 6.00	610 x 508 x 152	Galvanized	14	16	4
ASE24X24X6NK	24.00 x 24.00 x 6.00	610 x 610 x 152	Painted	14	16	4
ASG24X24X6NK	24.00 x 24.00 x 6.00	610 x 610 x 152	Galvanized	14	16	4
ASE30X24X6NK	30.00 x 24.00 x 6.00	762 x 610 x 152	Painted	14	16	6
ASG30X24X6NK	30.00 x 24.00 x 6.00	762 x 610 x 152	Galvanized	14	16	6
ASE30X30X6NK	30.00 x 30.00 x 6.00	762 x 762 x 152	Painted	12	12	8
ASG30X30X6NK	30.00 x 30.00 x 6.00	762 x 762 x 152	Galvanized	12	12	8
ASE36X24X6NK	36.00 x 24.00 x 6.00	914 x 610 x 152	Painted	14	16	6
ASG36X24X6NK	36.00 x 24.00 x 6.00	914 x 610 x 152	Galvanized	14	16	6
ASE36X30X6NK	36.00 x 30.00 x 6.00	914 x 762 x 152	Painted	12	12	8
ASG36X30X6NK	36.00 x 30.00 x 6.00	914 x 762 x 152	Galvanized	12	12	8
ASE36X36X6NK	36.00 x 36.00 x 6.00	914 x 914 x 152	Painted	12	12	8
ASG36X36X6NK	36.00 x 36.00 x 6.00	914 x 914 x 152	Galvanized	12	12	8
ASE8X8X8NK	8.00 x 8.00 x 8.00	203 x 203 x 203	Painted	16	16	4
ASG8X8X8NK	8.00 x 8.00 x 8.00	203 x 203 x 203	Galvanized	16	16	4
ASE10X10X8NK	10.00 x 10.00 x 8.00	254 x 254 x 203	Painted	16	16	4
ASG10X10X8NK	10.00 x 10.00 x 8.00	254 x 254 x 203	Galvanized	16	16	4
ASE12X10X8NK	12.00 x 10.00 x 8.00	305 x 254 x 203	Painted	16	16	4
ASG12X10X8NK	12.00 x 10.00 x 8.00	305 x 254 x 203	Galvanized	16	16	4
ASE12X12X8NK	12.00 x 12.00 x 8.00	305 x 305 x 203	Painted	16	16	4
ASG12X12X8NK	12.00 x 12.00 x 8.00	305 x 305 x 203	Galvanized	16	16	4
ASE16X12X8NK	16.00 x 12.00 x 8.00	406 x 305 x 203	Painted	16	16	4
ASG16X12X8NK	16.00 x 12.00 x 8.00	406 x 305 x 203	Galvanized	16	16	4
ASE18X12X8NK	18.00 x 12.00 x 8.00	457 x 305 x 203	Painted	16	16	4
ASG18X12X8NK	18.00 x 12.00 x 8.00	457 x 305 x 203	Galvanized	16	16	4
ASE18X18X8NK	18.00 x 18.00 x 8.00	457 x 457 x 203	Painted	16	16	4
ASG18X18X8NK	18.00 x 18.00 x 8.00	457 x 457 x 203	Galvanized	16	16	4
ASE24X12X8NK	24.00 x 12.00 x 8.00	610 x 305 x 203	Painted	16	16	4
ASG24X12X8NK	24.00 x 12.00 x 8.00	610 x 305 x 203	Galvanized	16	16	4

Catalog Number	AxBxC in.	AxBxC mm	Style	Body Thickness (ga.)	Cover Thickness (ga.)	Number of Cover Screws
ASE24X18X8NK	24.00 x 18.00 x 8.00	610 x 457 x 203	Painted	16	14	4
ASG24X18X8NK	24.00 x 18.00 x 8.00	610 x 457 x 203	Galvanized	16	14	4
ASE24X20X8NK	24.00 x 20.00 x 8.00	610 x 508 x 203	Painted	16	16	4
ASG24X20X8NK	24.00 x 20.00 x 8.00	610 x 508 x 203	Galvanized	14	16	4
ASE24X24X8NK	24.00 x 24.00 x 8.00	610 x 610 x 203	Painted	14	16	4
ASG24X24X8NK	24.00 x 24.00 x 8.00	610 x 610 x 203	Galvanized	14	16	4
ASE30X24X8NK	30.00 x 24.00 x 8.00	762 x 610 x 203	Painted	14	16	6
ASG30X24X8NK	30.00 x 24.00 x 8.00	762 x 610 x 203	Galvanized	14	16	6
ASE30X30X8NK	30.00 x 30.00 x 8.00	762 x 762 x 203	Painted	12	12	8
ASG30X30X8NK	30.00 x 30.00 x 8.00	762 x 762 x 203	Galvanized	12	12	8
ASE36X24X8NK	36.00 x 24.00 x 8.00	914 x 610 x 203	Painted	14	16	6
ASG36X24X8NK	36.00 x 24.00 x 8.00	914 x 610 x 203	Galvanized	14	16	6
ASE36X36X8NK	36.00 x 36.00 x 8.00	914 x 914 x 203	Painted	12	12	8
ASG36X36X8NK	36.00 x 36.00 x 8.00	914 x 914 x 203	Galvanized	12	12	8
ASE12X12X10NK	12.00 x 12.00 x 10.00	305 x 305 x 254	Painted	16	16	4
ASG12X12X10NK	12.00 x 12.00 x 10.00	305 x 305 x 254	Galvanized	16	16	4
ASE18X12X10NK	18.00 x 12.00 x 10.00	457 x 305 x 254	Painted	16	16	4
ASG18X12X10NK	18.00 x 12.00 x 10.00	457 x 305 x 254	Galvanized	16	16	4
ASE18X18X10NK	18.00 x 18.00 x 10.00	457 x 457 x 254	Painted	16	16	4
ASG18X18X10NK	18.00 x 18.00 x 10.00	457 x 457 x 254	Galvanized	16	16	4
ASE24X12X10NK	24.00 x 12.00 x 10.00	610 x 305 x 254	Painted	16	16	4
ASG24X12X10NK	24.00 x 12.00 x 10.00	610 x 305 x 254	Galvanized	16	16	4
ASE24X18X10NK	24.00 x 18.00 x 10.00	610 x 457 x 254	Painted	16	14	4
ASG24X18X10NK	24.00 x 18.00 x 10.00	610 x 457 x 254	Galvanized	14	16	4
ASE24X24X10NK	24.00 x 24.00 x 10.00	610 x 610 x 254	Painted	14	16	4
ASG24X24X10NK	24.00 x 24.00 x 10.00	610 x 610 x 254	Galvanized	14	16	4
ASE30X24X10NK	30.00 x 24.00 x 10.00	762 x 610 x 254	Painted	14	16	6
ASG30X24X10NK	30.00 x 24.00 x 10.00	762 x 610 x 254	Galvanized	14	16	6
ASE30X30X10NK	30.00 x 30.00 x 10.00	762 x 762 x 254	Painted	12	12	8
ASG30X30X10NK	30.00 x 30.00 x 10.00	762 x 762 x 254	Galvanized	12	12	8
ASE36X24X10NK	36.00 x 24.00 x 10.00	914 x 610 x 254	Painted	14	16	6
ASG36X24X10NK	36.00 x 24.00 x 10.00	914 x 610 x 254	Galvanized	14	16	6
ASE36X36X10NK	36.00 x 36.00 x 10.00	914 x 914 x 254	Painted	12	12	8
ASG36X36X10NK	36.00 x 36.00 x 10.00	914 x 914 x 254	Galvanized	12	12	8
ASE12X12X12NK	12.00 x 12.00 x 12.00	305 x 305 x 305	Painted	16	16	4
ASG12X12X12NK	12.00 x 12.00 x 12.00	305 x 305 x 305	Galvanized	16	16	4
ASE24X12X12NK	24.00 x 12.00 x 12.00	610 x 305 x 305	Painted	16	16	4
ASG24X12X12NK	24.00 x 12.00 x 12.00	610 x 305 x 305	Galvanized	16	16	4
ASE18X18X12NK	18.00 x 18.00 x 12.00	457 x 457 x 305	Painted	16	16	4
ASG18X18X12NK	18.00 x 18.00 x 12.00	457 x 457 x 305	Galvanized	16	16	4
ASE24X18X12NK	24.00 x 18.00 x 12.00	610 x 457 x 305	Painted	16	14	4
ASG24X18X12NK	24.00 x 18.00 x 12.00	610 x 457 x 305	Galvanized	14	16	4
ASE24X24X12NK	24.00 x 24.00 x 12.00	610 x 610 x 305	Painted	16	16	4
ASG24X24X12NK	24.00 x 24.00 x 12.00	610 x 610 x 305	Galvanized	14	16	4
ASE30X24X12NK	30.00 x 24.00 x 12.00	762 x 610 x 305	Painted	14	16	6
ASG30X24X12NK	30.00 x 24.00 x 12.00	762 x 610 x 305	Galvanized	12	12	8
ASE30X30X12NK	30.00 x 30.00 x 12.00	762 x 762 x 305	Painted	12	12	8
ASG30X30X12NK	30.00 x 30.00 x 12.00	762 x 762 x 305	Galvanized	12	12	8
ASE36X24X12NK	36.00 x 24.00 x 12.00	914 x 610 x 305	Painted	14	16	6
ASG36X24X12NK	36.00 x 24.00 x 12.00	914 x 610 x 305	Galvanized	14	16	6
ASE36X36X12NK	36.00 x 36.00 x 12.00	914 x 914 x 305	Painted	12	12	8
ASG36X36X12NK	36.00 x 36.00 x 12.00	914 x 914 x 305	Galvanized	12	12	8
ASE48X48X12NK	48.00 x 48.00 x 12.00	1219 x 1219 x 305	Painted	12	12	12
ASG48X48X12NK	48.00 x 48.00 x 12.00	1219 x 1219 x 305	Galvanized	12	12	12
ASE30X30X16NK	30.00 x 30.00 x 16.00	762 x 762 x 406	Painted	12	12	8
ASG30X30X16NK	30.00 x 30.00 x 16.00	762 x 762 x 406	Galvanized	12	12	8
ASE36X36X16NK	36.00 x 36.00 x 16.00	914 x 914 x 406	Painted	12	12	8
ASG36X36X16NK	36.00 x 36.00 x 16.00	914 x 914 x 406	Galvanized	12	12	8
ASE48X48X16NK	48.00 x 48.00 x 16.00	1219 x 1219 x 406	Painted	12	12	12
ASG48X48X16NK	48.00 x 48.00 x 16.00	1219 x 1219 x 406	Galvanized	12	12	12

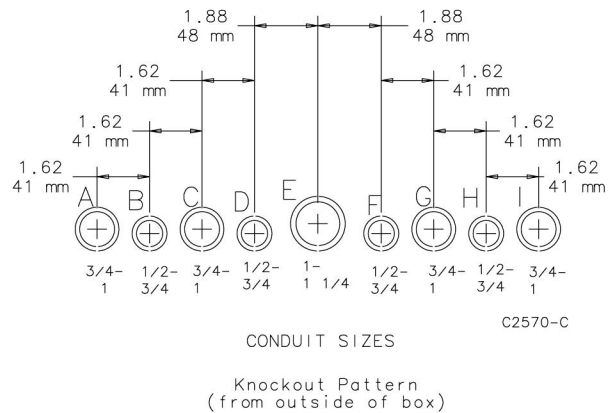
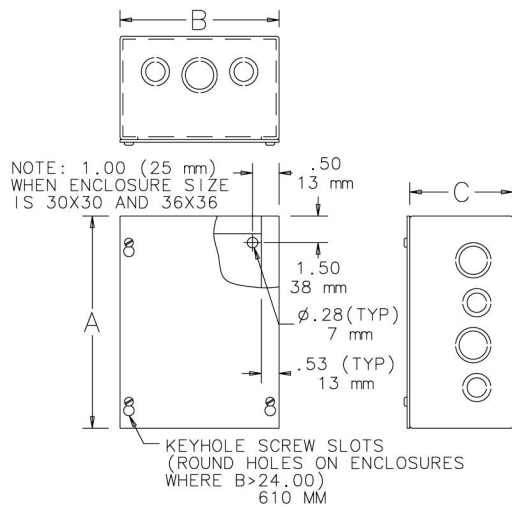

Designed to mount on enclosure for flush installations. Cover is 16 or 14 gauge steel finished with ANSI 61 gray polyester powder paint.

BULLETIN: A90P1

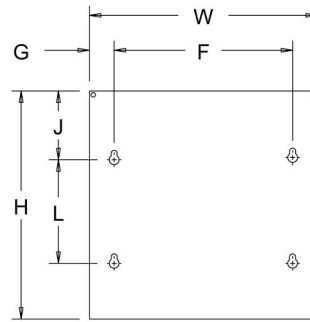

87948556

Standard Product

Catalog Number	H in./mm	W in./mm	Fits Box Size A x B in./mm	F in./mm	G in./mm	J in./mm	L in./mm	Cover Gauge
AFE6X6	7.50 191	7.50 191	6.00 x 6.00 152 x 152	5.44 138	1.03 26	3.75 95	—	16
AFE8X6	9.50 241	7.50 191	8.00 x 6.00 203 x 152	5.44 138	1.03 26	4.75 121	—	16
AFE8X8	9.50 241	9.50 241	8.00 x 8.00 203 x 203	7.44 189	1.03 26	2.77 70	4.31 109	16
AFE10X8	11.50 292	9.50 241	10.00 x 8.00 254 x 203	7.44 189	1.03 26	2.77 70	6.31 160	16
AFE10X10	11.50 292	11.50 292	10.00 x 10.00 254 x 254	9.44 240	1.03 26	2.77 70	6.31 160	16
AFE12X8	13.50 343	9.50 241	12.00 x 8.00 305 x 203	7.44 189	1.03 26	2.77 70	8.31 211	16
AFE12X12	13.50 343	13.50 343	12.00 x 12.00 305 x 305	11.44 291	1.03 26	2.77 70	8.31 211	16
AFE18X12	19.50 495	13.50 343	18.00 x 12.00 457 x 305	11.44 291	1.03 26	2.77 70	14.31 363	16
AFE18X18	19.50 495	19.50 495	18.00 x 18.00 457 x 457	17.44 443	1.03 26	2.77 70	14.31 363	16
AFE24X18	25.50 648	19.50 495	24.00 x 18.00 610 x 457	17.41 442	1.05 27	2.77 70	20.31 516	14
AFE24X24	25.50 648	25.50 648	24.00 x 24.00 610 x 610	23.41 595	1.05 27	2.77 70	20.31 516	14

FLUSH-MOUNT DOOR FRAMES



- Rugged black composite slide latch
- Optional tamper-resistant lock kit includes cylinder lock, tamper-resistant screws and special driver bit.
- Lock Kit: ACLDFD
- 14 gauge steel door frame has ANSI 61 gray polyester powder paint finish

BULLETIN: A90P1

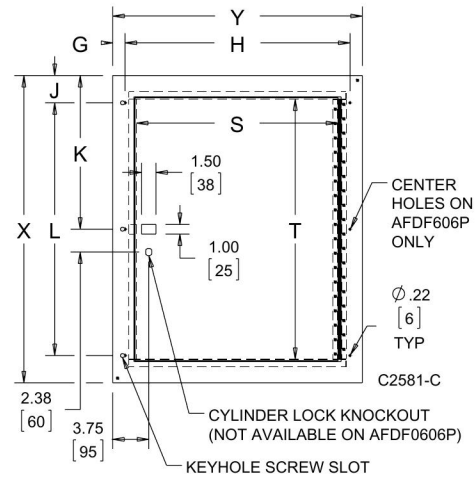

Use in Screw-Cover Pull Box telephone cabinet installations or in communication wiring and signal systems. Also as a junction or pull box and switch enclosure.

- Continuous hinge

Standard Product

Catalog Number	Frame Size X x Y in./mm	Door Size T in./mm	Door Size S in./mm	Fits Box Size A x B in./mm	G in./mm	H in./mm	J in./mm	K in./mm	L in./mm
AFDF0606P	8.00 x 8.00 203 x 203	3.00 76	3.00 76	6.00 x 6.00 152 x 152	1.28 32	5.44 138	N/A N/A	4.00 102	N/A N/A
AFDF1212P	14.00 x 14.00 356 x 356	9.00 229	9.00 229	12.00 x 12.00 305 x 305	1.28 32	11.44 291	2.84 72	7.00 178	8.31 211
AFDF1812P	20.00 x 14.00 508 x 356	15.00 381	9.00 229	18.00 x 12.00 457 x 305	1.28 32	11.44 291	2.84 72	10.00 254	14.31 364
AFDF1818P	20.00 x 20.00 508 x 508	15.00 381	15.00 381	18.00 x 18.00 457 x 457	1.28 32	17.44 443	2.84 72	10.00 254	14.31 364
AFDF2418P	26.00 x 20.00 660 x 508	21.00 533	15.00 381	24.00 x 18.00 610 x 457	1.28 32	17.44 443	2.84 72	13.00 330	20.31 516
AFDF2424P	26.00 x 26.00 660 x 660	21.00 533	21.00 533	24.00 x 24.00 610 x 610	1.30 33	23.41 595	2.84 72	13.00 330	20.31 516
AFDF3024P	32.00 x 26.00 813 x 660	27.00 686	21.00 533	30.00 x 24.00 762 x 610	1.30 33	23.41 595	2.84 72	16.00 406	26.31 668

TYPE 1 LOCKING WINDOW PULL BOX ACCESSORY

Flush- or surface-mount accessory fits Screw Cover, Type 1, boxes to prevent public access to lighting switches and controls. Includes a removable aluminum dead-front mounting surface for component cutouts and four torx-head screws for securing to enclosure.

BULLETIN: A90P1



Standard Product

Catalog Number	AxB in./mm	Dead Front Panel Size D x E in./mm	Mounting Holes G x H in./mm	Window Size M x N in./mm	Fits Pull Boxes with A x B dimensions of in./mm
ALDF88W	9.00 x 9.00 229 x 293	6.00 x 6.14 152 x 99	4.31 x 7.44 109 x 189	6.25 x 3.88 164 x 156	8X8 203 x 203
ALDF1212W	13.00 x 13.00 330 x 330	10.00 x 10.14 254 x 200	8.31 x 11.44 211 x 291	10.25 x 7.88 265 x 258	12X12 305 x 305

A x B = Frame Size

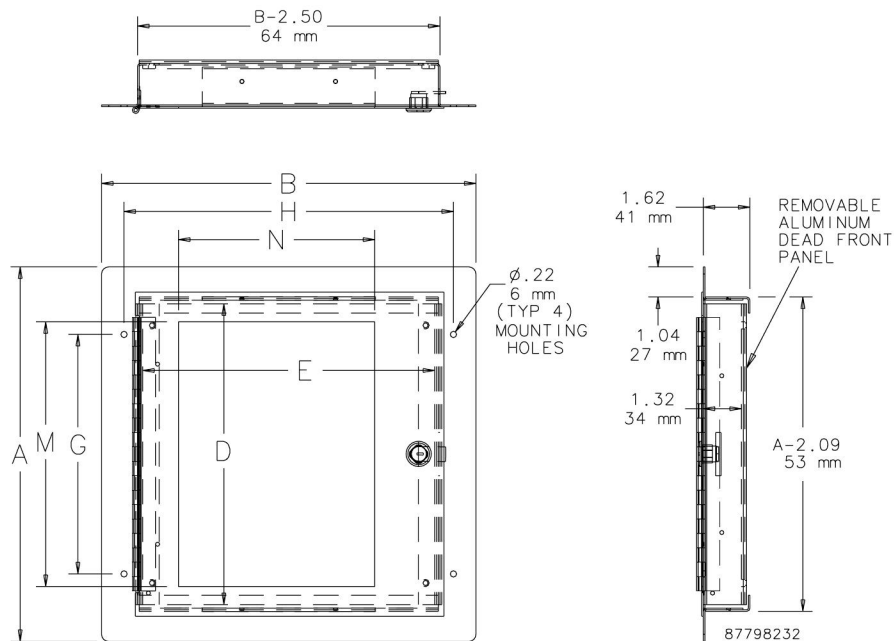

TYPE 1 PULL BOX PERFORATED PANEL

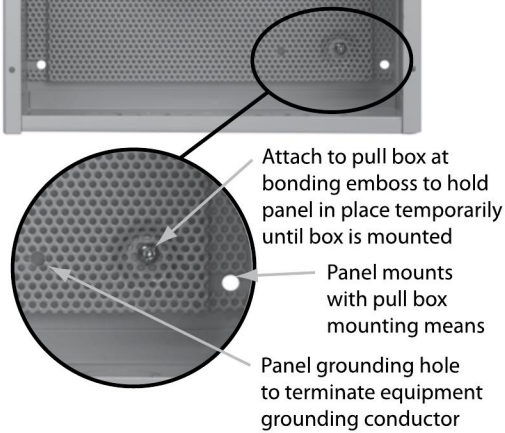
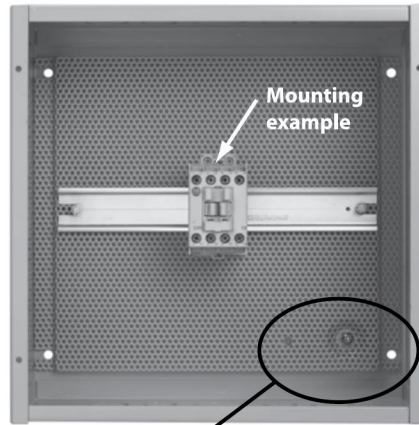
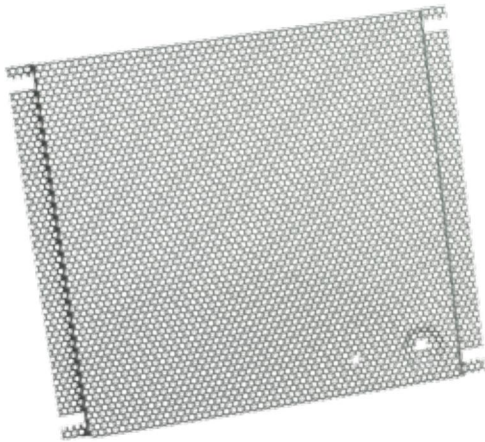

Panel is formed to provide 7/16-in. space off back of pull box for component mounting screw clearance and includes a grounding hole to terminate equipment grounding conductors. Ideal for mounting components that require infrequent access such as control transformers, terminals and contactors.

BULLETIN: PNLP

Standard Product

Catalog Number	Panel Gauge	Panel Size D x E (in.)	Panel Size D x E (mm)	Fits Pull Box
PB66PP	16	4.40 x 5.50	112 x 140	ASE6X6X
PB88PP	16	6.40 x 7.50	163 x 191	ASE8X8X
PB1212PP	16	10.40 x 11.50	264 x 292	ASE12X12X
PB1818PP	16	16.40 x 17.50	417 x 445	ASE18X18X
PB2424PP	16	22.40 x 23.50	569 x 597	ASE24X24X

PB1818PP and PB2424PP are flanged on all four sides.

